

1W 3KV DC/DC Converters



SMD Unregulated 1Watt 3KV Isolated DC/DC Converters



Product Features:

- DC/DC 1W Unregulated Converters
- 3KVdc Isolation Voltage
- Functional Insulation
- Operating Temperature -40C to +105C
- High Efficiency & Low Ripple/Noise
- Continuous Short-Circuit Protection
- Meets UL/EN62368-1

1 Watt, 3KV

Part Number	Input Voltage ¹	Output Voltage	Input Current No-Load/Full-Load	Max Output Current	Output Ripple/Noise ²	Efficiency @ Full Load
DC13-V0303SLF	3.3V	3.3V	5 / 370mA	300mA	50mV	81%
DC13-V0305SLF	3.3V	5V	7 / 360mA	200mA	40mV	85%
DC13-V0312SLF	3.3V	12V	8 / 340mA	84mA	25mV	89%
DC13-V0503SLF	5V	3.3V	3 / 240mA	300mA	50mV	82%
DC13-V0505SLF	5V	5V	4 / 230mA	200mA	50mV	86%
DC13-V0512SLF	5V	12V	7 / 230mA	84mA	30mV	90%
DC13-V1203SLF	12V	3.3V	2 / 100mA	300mA	65mV	82%
DC13-V1205SLF	12V	5V	2 / 100mA	200mA	50mV	87%
DC13-V1212SLF	12V	12V	4 / 100mA	84mA	25mV	90%

Notes:

¹Maximum input voltage range +/-10% from nominal

²Output ripple/noise tested with a 4.7uF capacitor at input and 10uF capacitor at output of the device @ 20MHz BW

³Line regulation: +/-1.3% per 1% input change for 3.3V versions and less than +/-1.2% for all other devices

⁴RoHS exemption 7(c)-1 is applicable to internal chip resistor

Output Voltage vs. Load

1W

3.3Vin — 5Vin — 12Vin —

3.3V OUTPUT VOLTAGE VS. LOAD

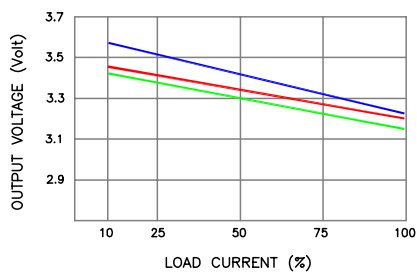

DC13-V0303SLF
DC13-V0503SLF
DC13-V1203SLF

5V OUTPUT VOLTAGE VS. LOAD

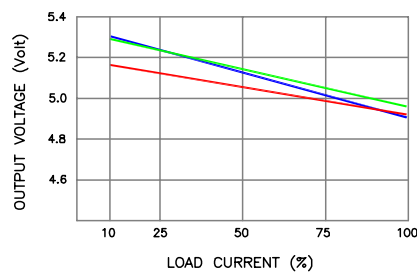

DC13-V0305SLF
DC13-V0505SLF
DC13-V1205SLF

12V OUTPUT VOLTAGE VS. LOAD

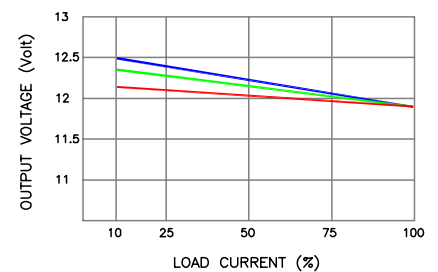

DC13-V0312SLF
DC13-V0512SLF
DC13-V1212SLF

For additional information contact your [local representative](#), or HALO's support staff at (650) 903-3800 or info@haloelectronics.com

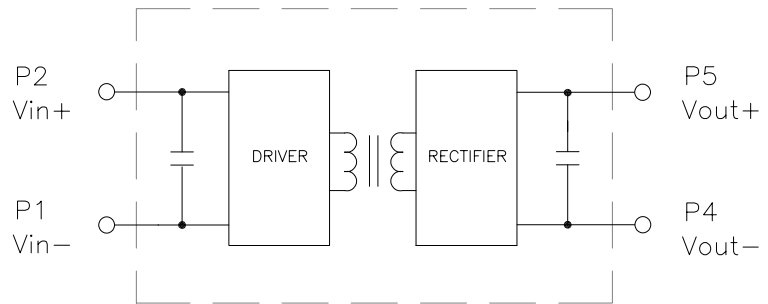
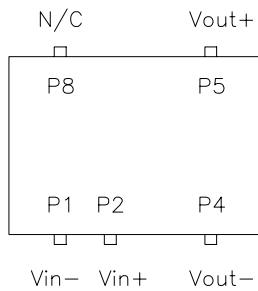

Mechanical

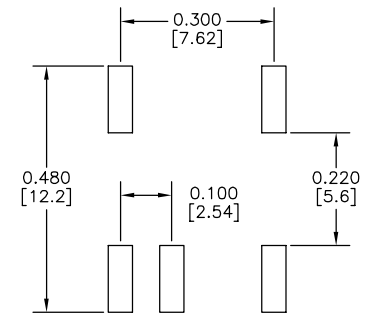
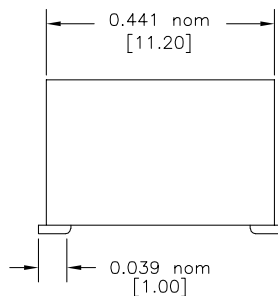
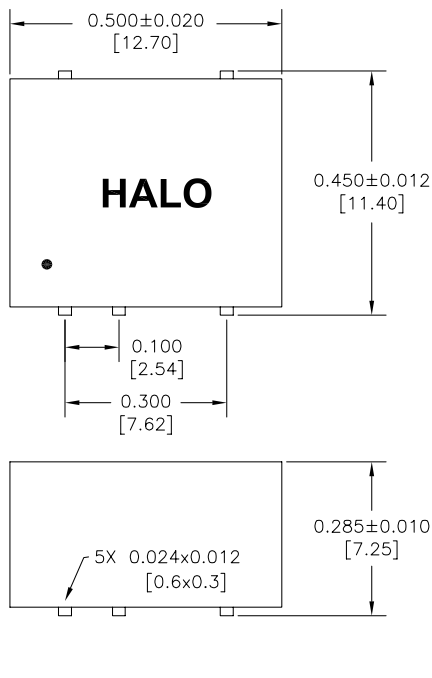

RECOMMENDED SOLDER PAD DIM.

Dimension: inch [mm]



Santa Clara, CA 95054
(650) 903-3800

info@haloelectronics.com
www.haloelectronics.com

HALO® Electronics is a leading supplier of high quality communication magnetics including signal transformers, filters, CMR chokes, PoE power transformers, DC/DC isolation modules, and integrated Ethernet connectors. HALO's high quality and competitively priced leading edge technology solutions are manufactured in ISO9001 and ISO14001 factories.