



### Product Features:

- Integrated Common Mode Filters
- For use in Gigabit and 10/100BASE-TX Circuits
- Proprietary Robust Contact Design
- 30µ" Gold Plating (min) on Contacts
- UL Recognized Materials

Part Number	Circuit	Application	Temp Range	LED's (L/R)	Choke OCL (min)	Winding DCR (max)	Cw/w (max)	Isolation
HFJ11-CMC1ERL	A	10/100	-40 to +85°C	None	35µH	0.4Ω	15pF	500Vrms
HFJ11-CMC1E-L11RL	A	10/100	-40 to +85°C	G/G	35µH	0.4Ω	15pF	500Vrms
HFJ11-CMC1E-L12RL	A	10/100	-40 to +85°C	G/Y	35µH	0.4Ω	15pF	500Vrms
HFJ11-CMC1E-L21RL	A	10/100	-40 to +85°C	Y/G	35µH	0.4Ω	15pF	500Vrms
HFJ11-CMRP1ERL	B	10/100 (PoE)	-40 to +85°C	None	35uH	0.4Ω	15pF	500Vrms
HFJ11-CMRP1E-L11RL	B	10/100 (PoE)	-40 to +85°C	G/G	35uH	0.4Ω	15pF	500Vrms
HFJ11-CMRP1E-L12RL	B	10/100 (PoE)	-40 to +85°C	G/Y	35uH	0.4Ω	15pF	500Vrms
HFJ11-CMRP1E-L21RL	B	10/100 (PoE)	-40 to +85°C	Y/G	35uH	0.4Ω	15pF	500Vrms
HFJ11-LG1GERL	C	Gigabit	-40 to +85°C	None	35µH	0.4Ω	15pF	500Vrms
HFJ11-LG1GE-L11RL	C	Gigabit	-40 to +85°C	G/G	35µH	0.4Ω	15pF	500Vrms
HFJ11-LG1GE-L12RL	C	Gigabit	-40 to +85°C	G/Y	35µH	0.4Ω	15pF	500Vrms
HFJ11-LG1GE-L21RL	C	Gigabit	-40 to +85°C	Y/G	35µH	0.4Ω	15pF	500Vrms
HFJ11-LGHRPERL*	D	Gigabit (PoE/PoE+)	-40 to +85°C	None	35uH	0.3Ω	25pF	500Vrms
HFJ11-LGHRPE-L11RL*	D	Gigabit (PoE/PoE+)	-40 to +85°C	G/G	35uH	0.3Ω	25pF	500Vrms
HFJ11-LGHRPE-L12RL*	D	Gigabit (PoE/PoE+)	-40 to +85°C	G/Y	35uH	0.3Ω	25pF	500Vrms
HFJ11-LGHRPE-L21RL*	D	Gigabit (PoE/PoE+)	-40 to +85°C	Y/G	35uH	0.3Ω	25pF	500Vrms

\* Can also be used for 10/100 PoE+

### Notes:

1. LED Key : G = Green, Y = Yellow
2. Other LED colors, bi-colors, polarities, and current limiting versions available
3. Unshielded or shielded without ground tabs available
4. Please contact the factory or representative for individual datasheets or additional information
5. Higher current CMC FastJacks available

# HALO Common Mode Choke (CMC) Family of FastJacks

## Circuit A

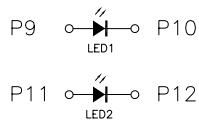
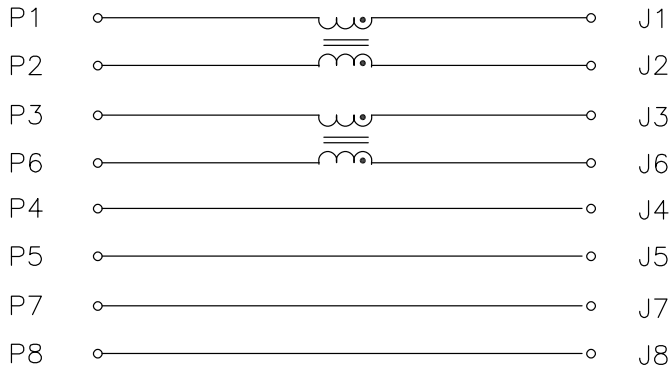

## Circuit B

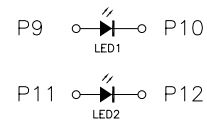
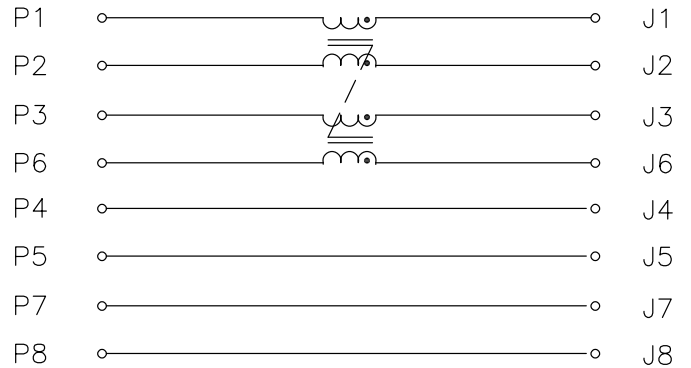

## Circuit C

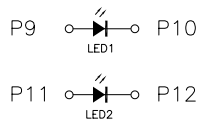
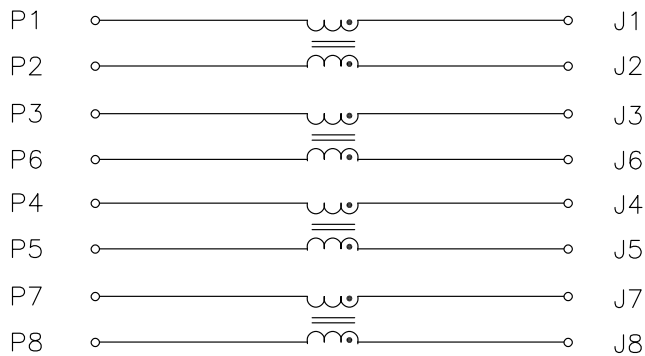

## Circuit D

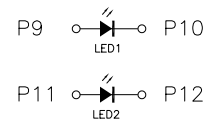
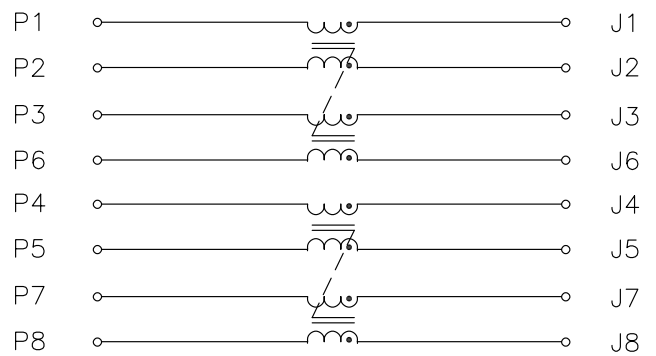

# HALO Common Mode Choke (CMC) Family of FastJacks

## Mechanical

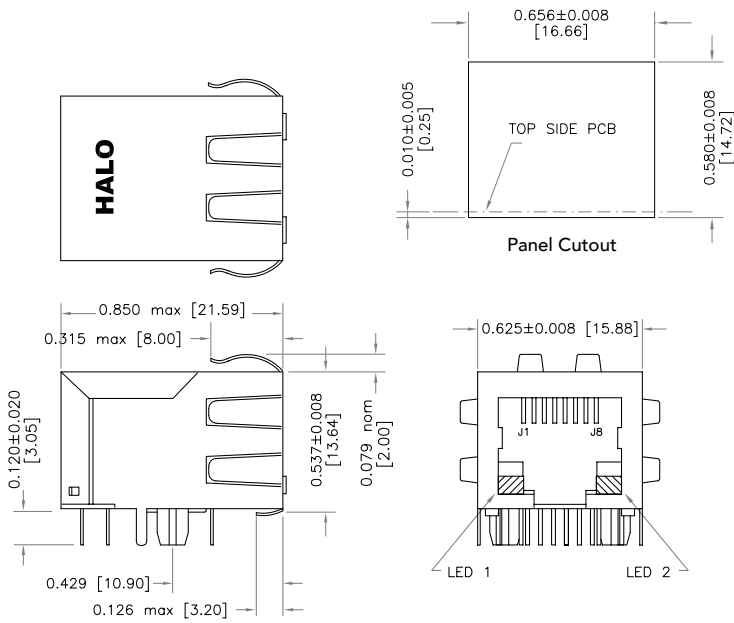

Dimensions are in inches [mm]

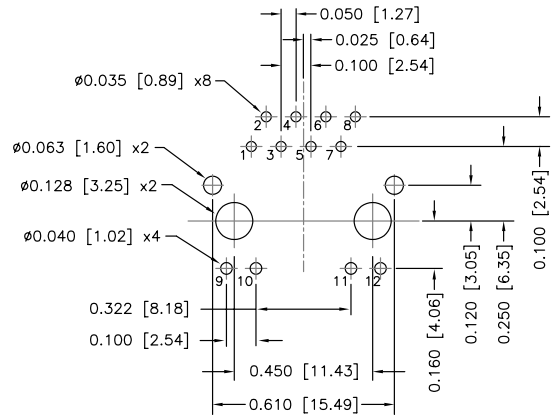

Recommended PCB Layout (Component Side)

\* Parts numbers without LED's omit pins 9 through 12



2933 Bunker Hill Lane #200  
 Santa Clara, CA 95054  
 (650) 903-3800  
[www.haloelectronics.com](http://www.haloelectronics.com)

HALO® Electronics is a leading supplier of high quality communication magnetics including signal transformers, filters, CMR chokes, PoE power transformers, DC/DC converters, and integrated Ethernet connectors. HALO's leading edge technology solutions are manufactured in ISO9001 and ISO14001 factories offering high quality products at a competitive price.