

Product Features:

- 10/100BASE-TX Ethernet RJ45
- IEEE802.3u Compliant
- 350uH min OCL at 8mA DC Bias Across the Full Temp Range
- 30µ" Gold Plating (min) on Contacts
- 100% Compliance Testing
- 1500Vrms Hi-Pot
- Proprietary Robust Contact Design

Part Number		Ports	Circuit	LED's (L/R)	Return Loss (min)				Insertion Loss (max)
Standard Temp (0 to 70°C)	Extended Temp (-40 to +85°C)				1-30MHz	40MHz	50MHz	60-80MHz	
HFJ12-2450ERL	HFJ12-E2450ERL	2	A	None	-18dB	-15.5dB	-13.6dB	-12dB	-1.1dB
HFJ12-2450ER-L11RL	HFJ12-E2450ER-L11RL	2	A	G/G	-18dB	-15.5dB	-13.6dB	-12dB	-1.1dB
HFJ12-2450ER-L12RL	HFJ12-E2450ER-L12RL	2	A	G/Y	-18dB	-15.5dB	-13.6dB	-12dB	-1.1dB
HFJ12-2450ER-L15RL	HFJ12-E2450ER-L15RL	2	A	G/G(Y)	-18dB	-15.5dB	-13.6dB	-12dB	-1.1dB
HFJ12-2450ER-L17RL	HFJ12-E2450ER-L17RL	2	A	G/G(O)	-18dB	-15.5dB	-13.6dB	-12dB	-1.1dB
HFJ12-2450ER-L21RL	HFJ12-E2450ER-L21RL	2	A	Y/G	-18dB	-15.5dB	-13.6dB	-12dB	-1.1dB
HFJ12-2450ER-L55RL	HFJ12-E2450ER-L55RL	2	A	G(Y)/G(Y)	-18dB	-15.5dB	-13.6dB	-12dB	-1.1dB
HFJ12-2450ER-L77RL	HFJ12-E2450ER-L77RL	2	A	G(O)/G(O)	-18dB	-15.5dB	-13.6dB	-12dB	-1.1dB
HFJ12-2450ER-L78RL	HFJ12-E2450ER-L78RL	2	A	G(O)/O(G)	-18dB	-15.5dB	-13.6dB	-12dB	-1.1dB
HFJ14-2450ERL	HFJ14-E2450ERL	4	A	None	-18dB	-15.5dB	-13.6dB	-12dB	-1.1dB
HFJ14-2450ER-L11RL	HFJ14-E2450ER-L11RL	4	A	G/G	-18dB	-15.5dB	-13.6dB	-12dB	-1.1dB
HFJ14-2450ER-L12RL	HFJ14-E2450ER-L12RL	4	A	G/Y	-18dB	-15.5dB	-13.6dB	-12dB	-1.1dB
HFJ14-2450ER-L15RL	HFJ14-E2450ER-L15RL	4	A	G/G(Y)	-18dB	-15.5dB	-13.6dB	-12dB	-1.1dB
HFJ14-2450ER-L17RL	HFJ14-E2450ER-L17RL	4	A	G/G(O)	-18dB	-15.5dB	-13.6dB	-12dB	-1.1dB
HFJ14-2450ER-L21RL	HFJ14-E2450ER-L21RL	4	A	Y/G	-18dB	-15.5dB	-13.6dB	-12dB	-1.1dB
HFJ14-2450ER-L55RL	HFJ14-E2450ER-L55RL	4	A	G(Y)/G(Y)	-18dB	-15.5dB	-13.6dB	-12dB	-1.1dB
HFJ14-2450ER-L77RL	HFJ14-E2450ER-L77RL	4	A	G(O)/G(O)	-18dB	-15.5dB	-13.6dB	-12dB	-1.1dB
HFJ14-2450ER-L78RL	HFJ14-E2450ER-L78RL	4	A	G(O)/O(G)	-18dB	-15.5dB	-13.6dB	-12dB	-1.1dB

Notes:

1. LED Key : G = Green, Y = Yellow, O = Orange, () = Bi-Color
2. Other LED colors, bi-colors, polarities, and current limiting versions available
3. Unshielded and shielded without ground tabs available
4. Part specific datasheets available
5. Lightning strike and power line cross versions available

HALO 10/100BASE-T Ethernet Family of FastJacks

Circuit A

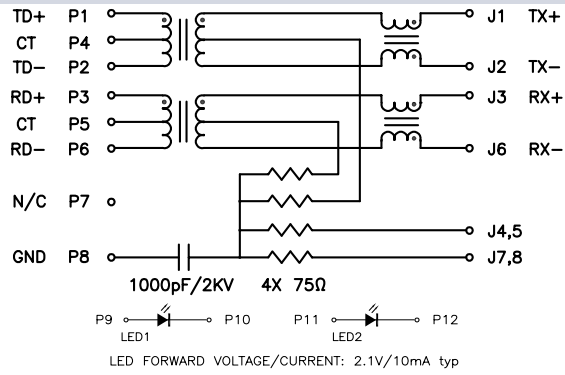

HFJ12 Mechanical - Without LED's

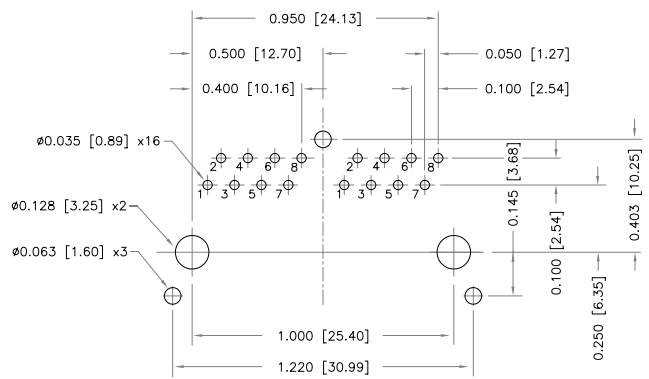
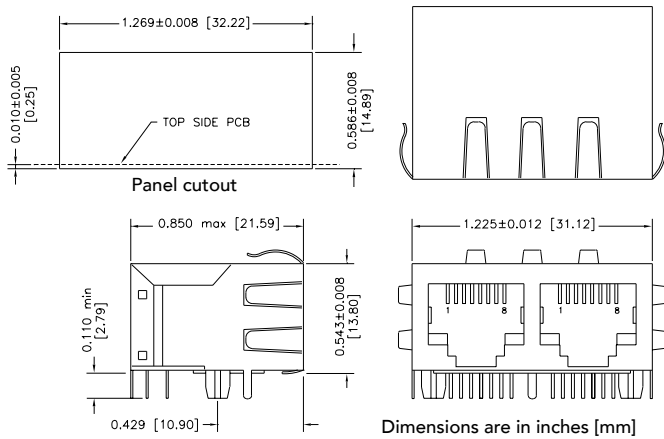

HFJ12 Mechanical - With LED's

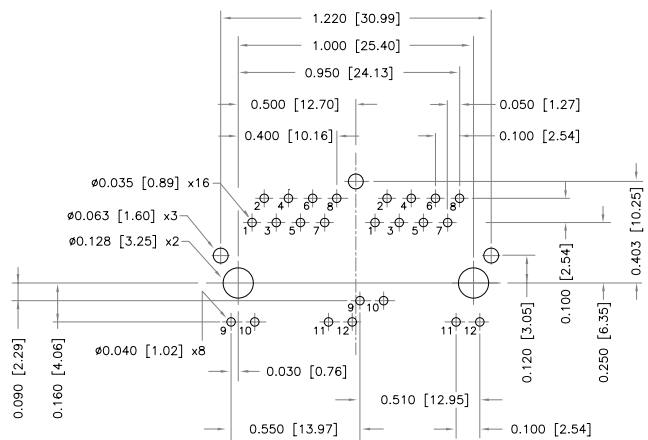
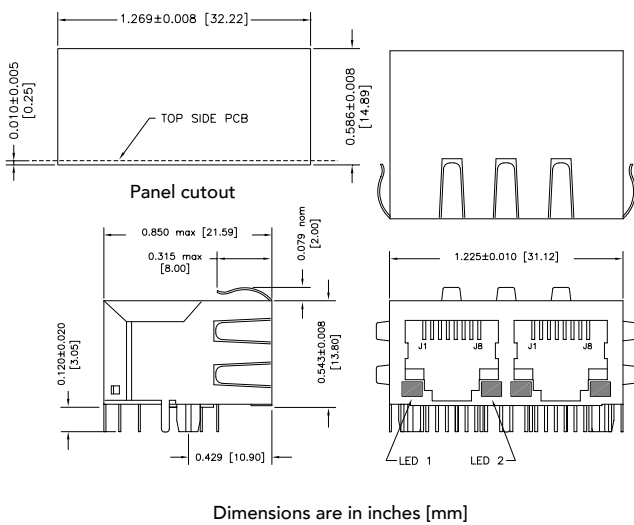

HALO 10/100BASE-T Ethernet Family of FastJacks

HFJ14 Mechanical - Without LED's

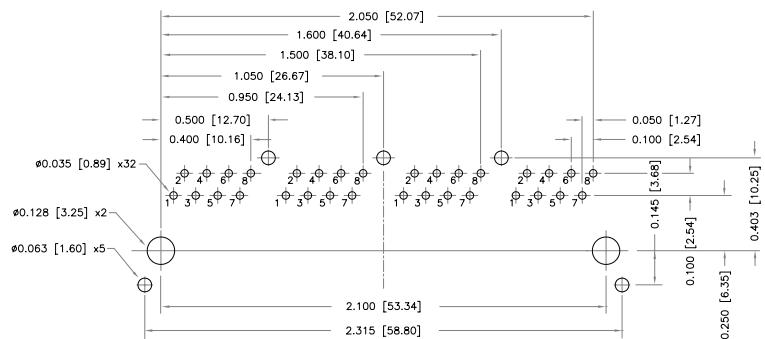
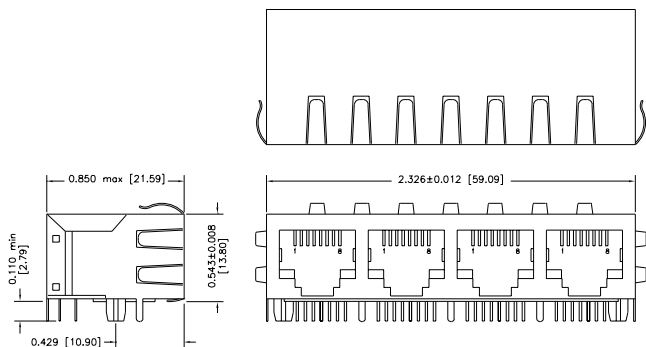

Recommended PCB Layout (Component Side)

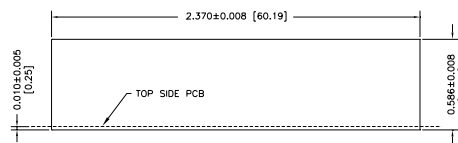

Panel cutout

Dimensions are in inches [mm]

HFJ14 Mechanical - With LED's

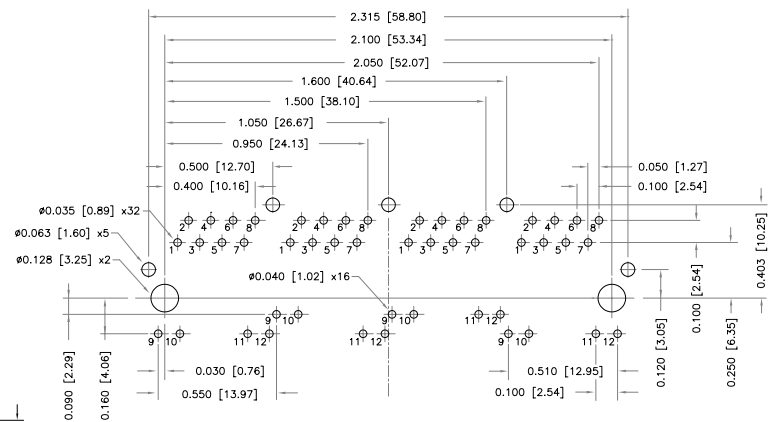
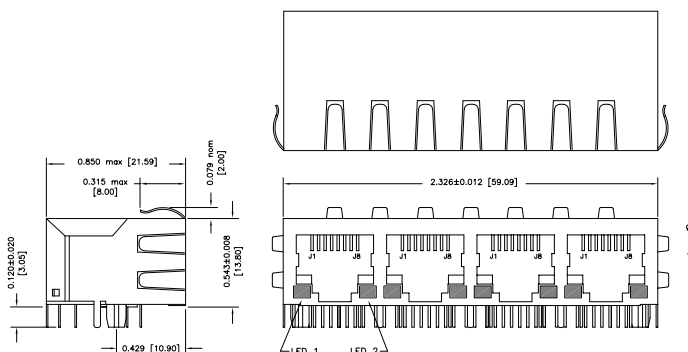

Recommended PCB Layout (Component Side)

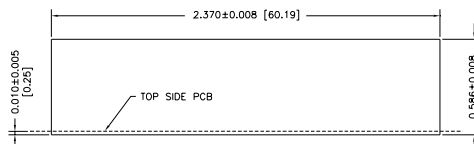

Panel cutout

Dimensions are in inches [mm]



2880 Lakeside Drive #116
Santa Clara, CA 95054
(650) 903-3800

www.haloelectronics.com

HALO® Electronics is a leading supplier of high quality communication magnetics including signal transformers, filters, CMR chokes, PoE power transformers, DC/DC converters, and integrated Ethernet connectors. HALO's leading edge technology solutions are manufactured in ISO9001 and ISO14001 factories offering high quality products at a competitive price.